

# MILKY LED

**TOP V / FLAT H / SLIM H / MINI TOP / DOME**

Installation Manual

# MILKY LED

## TOP V / FLAT H / SLIM H / MINI TOP / DOME

### Installation Manual

## Precaution

### Installation Temperature

#### PVC



Ambient Installation Temperature  
0 ~ 45°C / 32~113°F



Max. Mounting Surface Temperature \*  
60°C / 140°F

\*No operation of light

#### Silicone



Ambient Installation Temperature  
-40 ~ 50°C / -40~122°F



Max. Mounting Surface Temperature \*  
85°C / 185°F

\*No operation of light

### Min. Bending Diameter

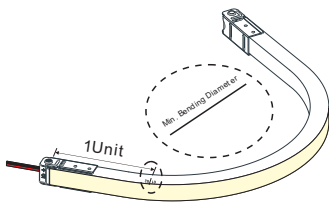
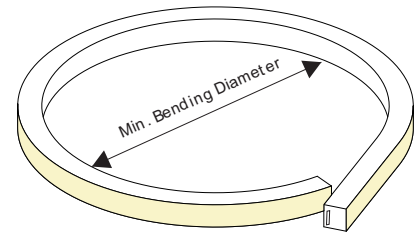
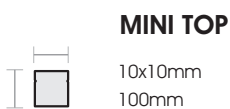
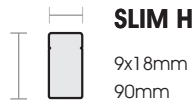
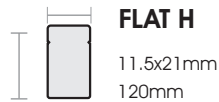
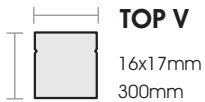

Please operate as per allowed bending diameter and avoid the bending at the first unit of light and connector, otherwise PCB and LEDs might be damaged.

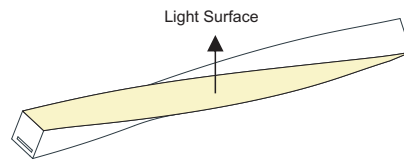

Do not twist or bend wrongly.  
Do not hit or pull the light hard.

### Bending Direction

Please note and follow the bending mark on the light body, otherwise it may cause the PCB damage and lead to the failure of light.

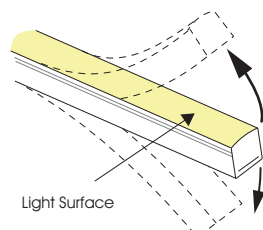

VB-Vertical Bending

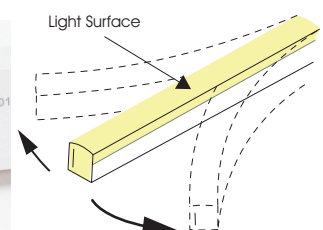

HB-Horizontal Bending

# Unpacking

## White Box Packaging

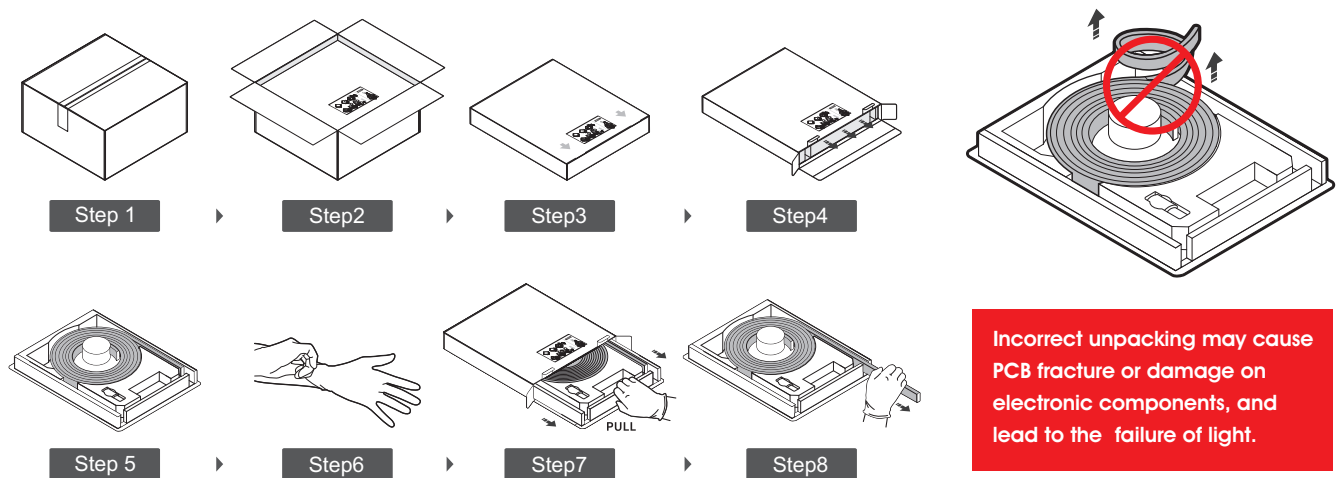

### 1. Check Working Voltage

Please confirm the light in good condition once received, and pay attention to the voltage connected with as overvoltage may burn out the light, see picture ①.

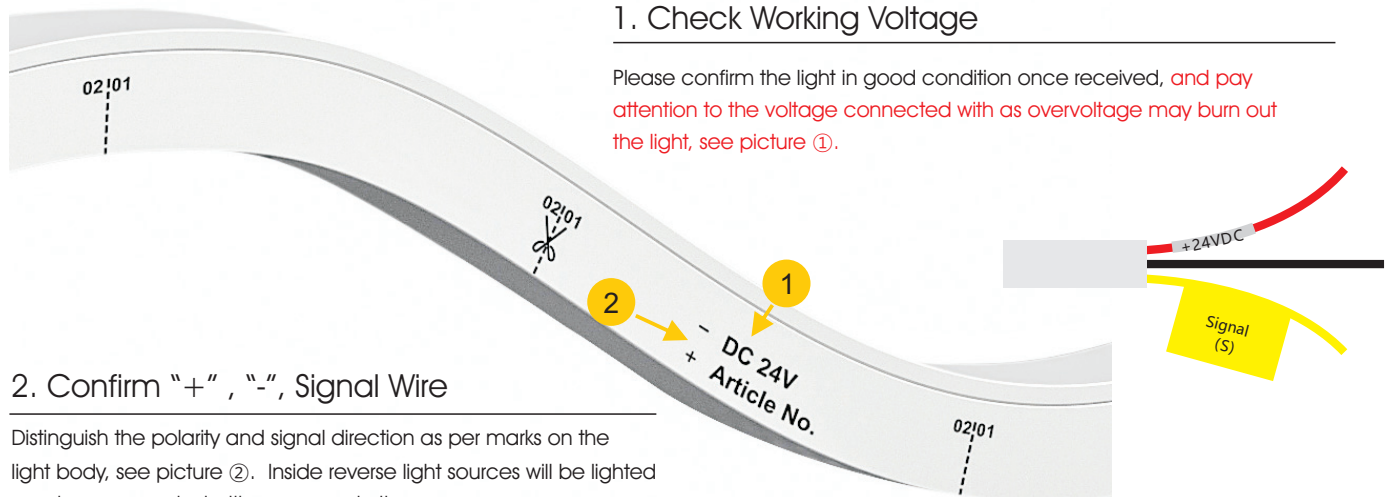

### 2. Confirm "+", "-", Signal Wire

Distinguish the polarity and signal direction as per marks on the light body, see picture ②. Inside reverse light sources will be lighted up when connected with reverse polarity. Please switch the connection to get back to normal.

### 3. Lighting

Please do not light up the products over 30 minutes in the coil package, otherwise it may cause the overheating of light and lead to the damage on housing material and inside electronic components.

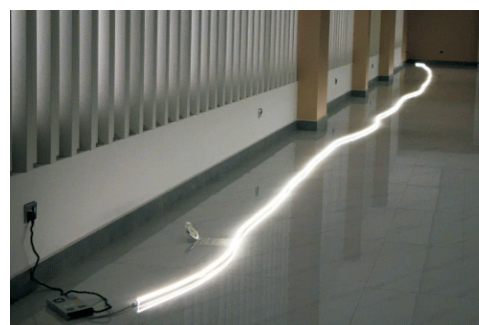

## Cable Requirement



It's recommended to keep at least 60mm cable in the natural state at the cable joint with light.

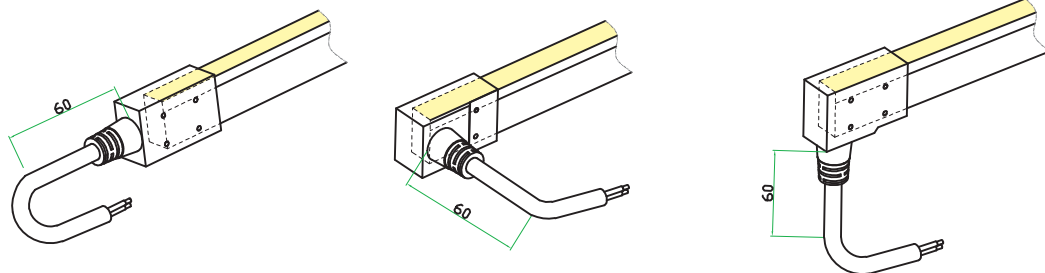

Do not pull the cable, otherwise it may disable the function of the connector and lead to water ingress.

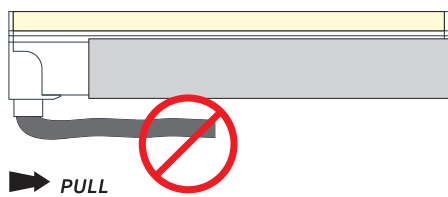
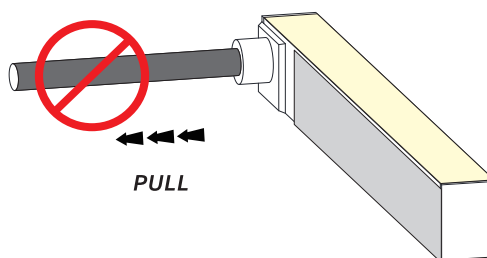
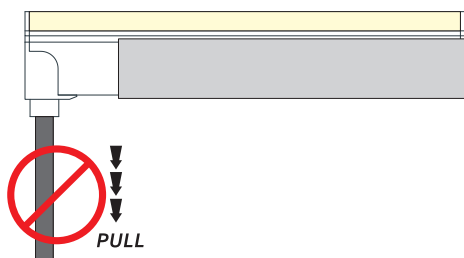

## Connector

### Glue on Connector

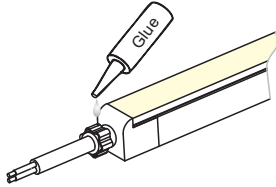

It's not recommended to glue on the space between connector and profile or mounting surface, otherwise the seam might occur at the cable joint with light due to the pulling force generated by contraction and expansion of the light and mounting surface, and then resulted in water ingress and the failure of product.

### Placement of Connector



It's recommended to reserve 10~20mm distance between the connector and mounting profile, otherwise the connector might be damaged due to contraction and expansion of the light and displacement of mounting profile, and then resulted in water ingress and the failure of product.

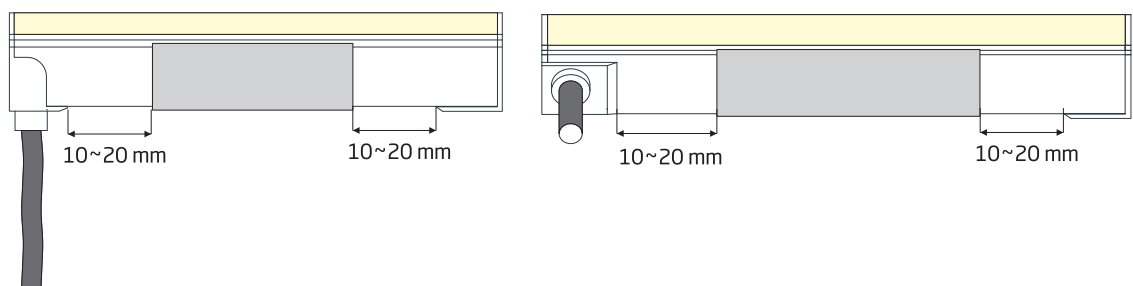
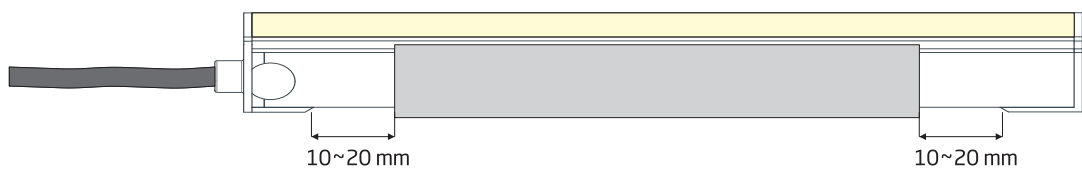
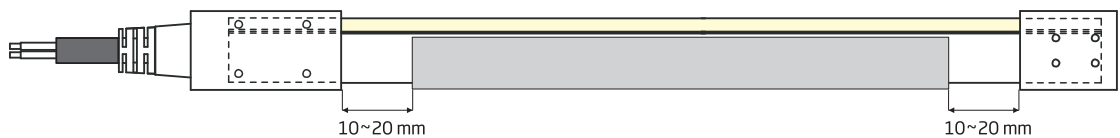

## Anti-wicking Ferrule

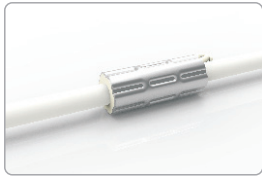

1. The removal of anti-wicking ferrule will increase the risk of water ingress and void the warranty out of it.

2. For underwater application, do not immerse anti-wicking ferrule in the water.

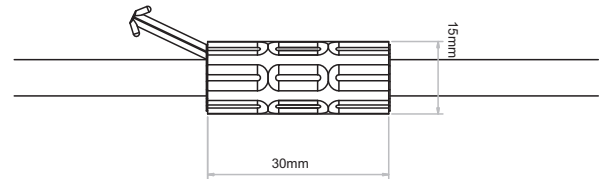
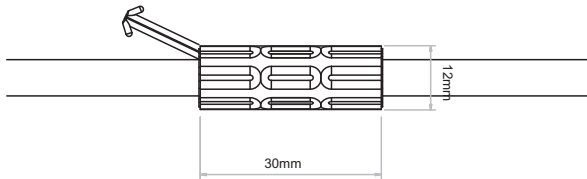

### Single colour



### 2 colours



### 3 colours



### 4 colours



Make sure no scratches on the cable sheath, otherwise water ingress may occur.



## Cable Join

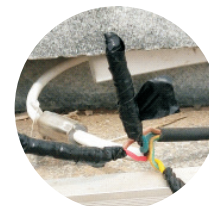

Please use a proper waterproof box or waterproof connector to do the cable treatment.

Wrap the cable by adhesive plaster only is not reliable, it will cause water ingress.

For underwater application, please keep the cable joint away from the wet environment, and choose IP68 rated connector.

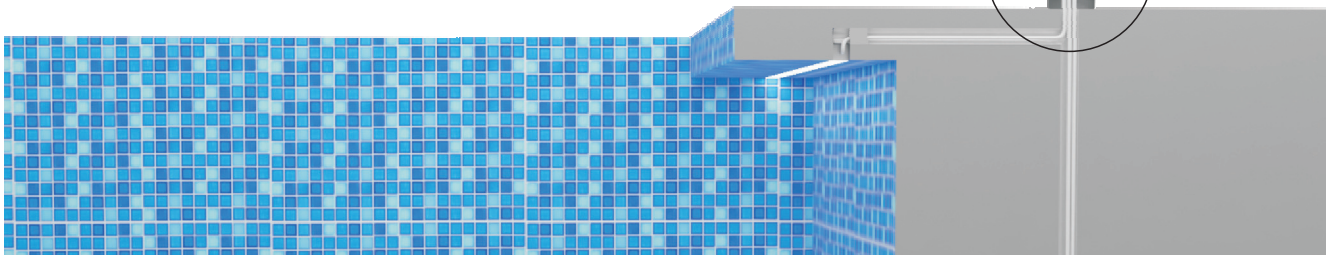

# Profile

## Profile Cutting

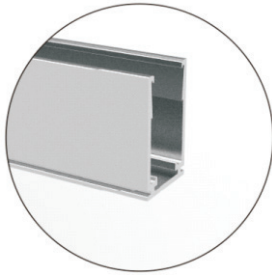

Make sure the cross-section of profile is smooth without any burrs when cutting, otherwise the light housing will be impaled and cause water ingress.

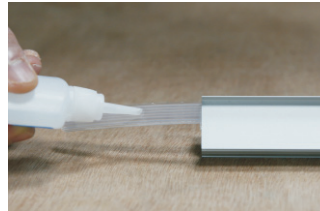

For the profiles involved serrated tape, in case of any drop of serrated tape after cutting, please insert and fix it to the profile by a few adhesive glues on its backside, 5~8mm diameter of touching area is enough. Make sure its round head on the edge is downward when putting back.



## Profile Installation

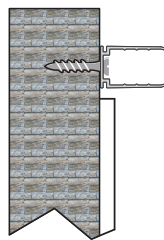
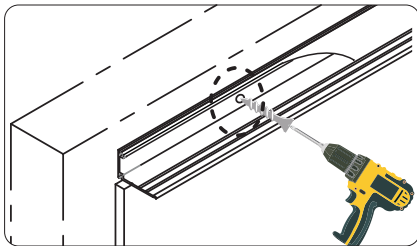

Install the screw into position and ensure the screw head is in line with or lower than the base of aluminum profile.

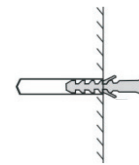

Place the rubber expansion bolt to assist with the screw fixation if the mounting surface is rigid.



Make sure no debris in the profile before installation to avoid the light housing being impaled and cause water ingress.

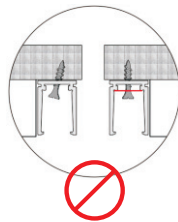

Make sure no bulges on the slot to avoid the damage on the light and cause water ingress.

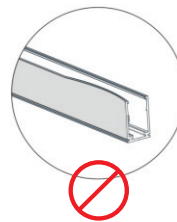

Do not use the profile deformed seriously.

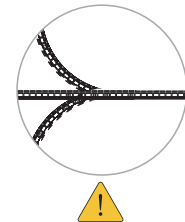

It's recommended to mount in place at a time when using the bendable aluminum profile in case of any break due to the frequent repeated shaping.

## Profile Jointing



1. Please reserve 5mm for profile jointing to enable enough space for contraction and expansion.



2. The profiles can be jointed to a right angle only if there are two pieces of lights connected to be a right angle.



3. For the curve shaping of light, make sure to leave enough space to separate profiles in between or use the bendable profile instead.

### 4. Splice Structure on Mounting Surface

In the case of an outdoor mounting surface with the splice structure, please make sure the mounting profile goes across the gap or separate the light and profile as per the splice structure.

When the profile jointing lies where the mounting surface splices, contraction and expansion of the mounting surface in the long term will cause the misalignment of profiles and lights, and lead to the damage of inside PCB.

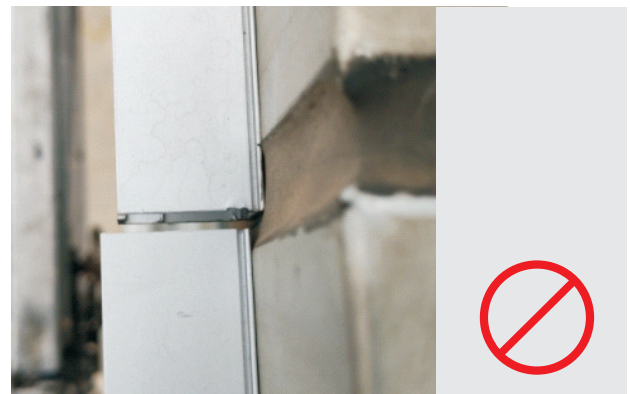
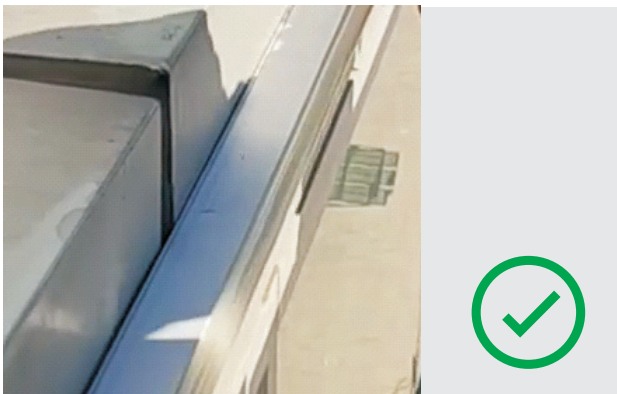

Angular Misalignment

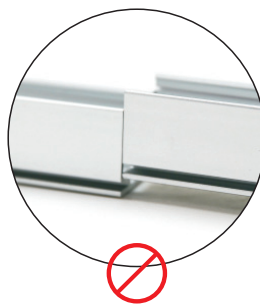

Parallel Vertical Misalignment

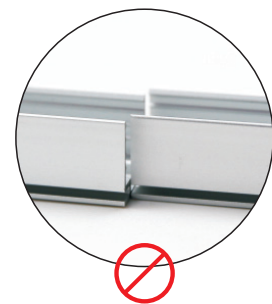

Parallel Horizontal Misalignment

Above wrong misalignments will make the light improperly bent, and lead to the wrinkle or fracture on PCB.



## Light Installation



It's not recommended to install the light repeatedly, otherwise the light inside might be damaged.



Make sure the light is fitted in vertically.



Press the light into the profile by the palm instead of the finger, otherwise it might damage inside electronic components due to the overpressure caused.

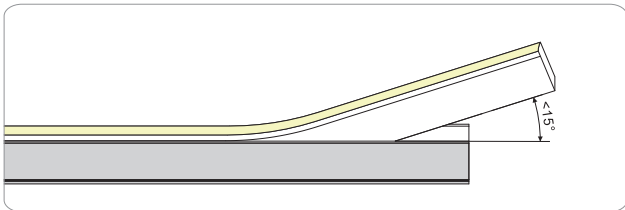

Make sure the angle between the light and profile is not bigger than  $15^\circ$ , otherwise inside PCB might be damaged.



When light length  $> 2m$ , make sure somebody helps to lift the light, in case the heavy weight of light itself generates too small bending angle or twisting, which may damage inside PCB.

Make sure the light body is not scratched during installation, otherwise the light housing will be impaled and cause water ingression.

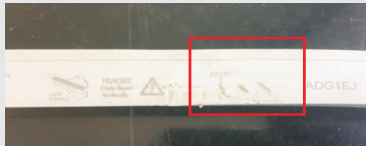

## Light Uninstallation

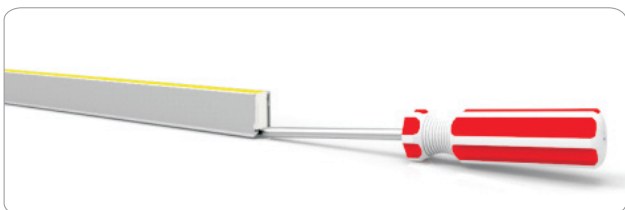

Prepare a screwdriver, and put the screwdriver at the bottom of light.

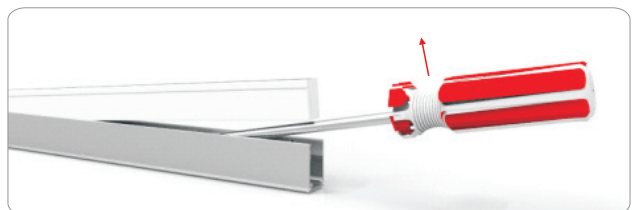

Move the screwdriver and unclench the light upwardly. Be careful the angle between the light and profile should not be bigger than  $15^\circ$ .



Once the end of light is out, hold both sides of light by hand and pull it out along the profile slowly and orderly. Make sure the angle between the light and profile is not bigger



When light length  $> 2m$ , make sure somebody helps to lift the light, in case the heavy weight of light itself generates too small bending angle or twisting, which may damage inside PCB.

# Wiring Diagram

Single colour

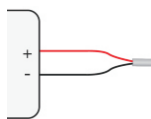

2 colours

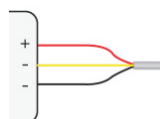

3 colours

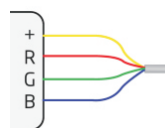

4 colours

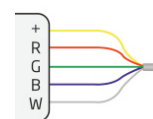

## Single-end Feed

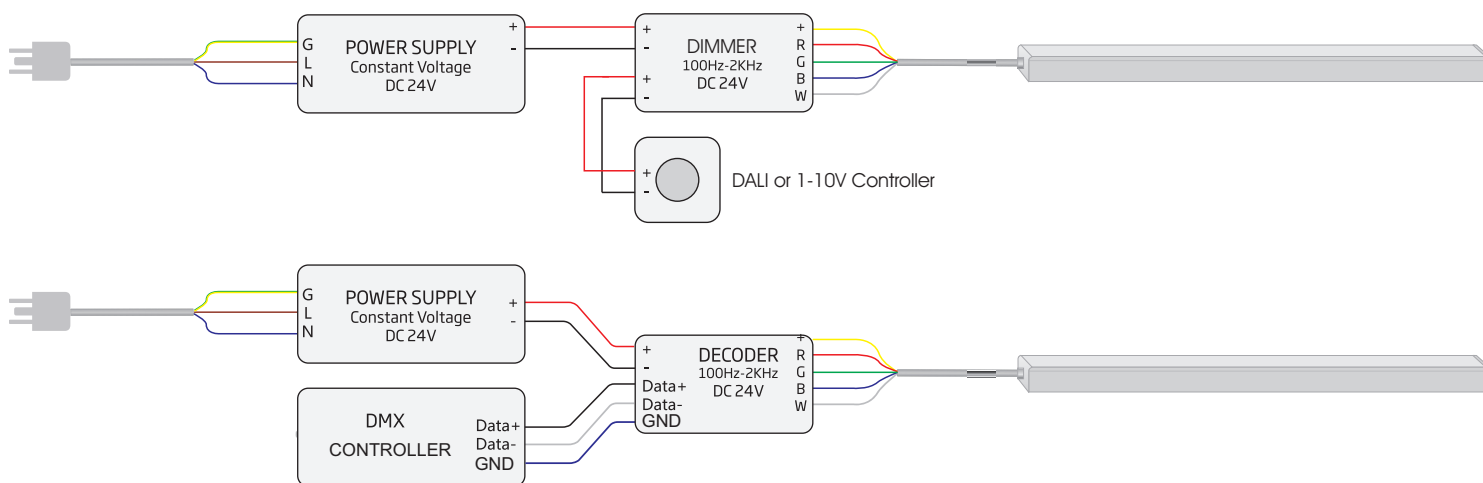

## Double-end Feed

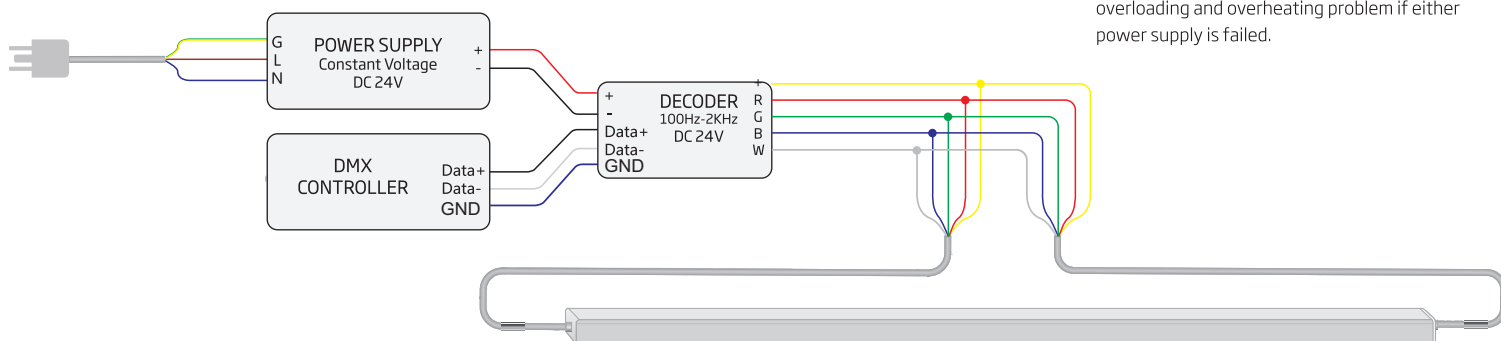

Please ensure the polarity connection is correct on both ends, and short circuit might occur if powering the light from both ends with reverse polarity. It is not recommended to feed both ends of light with two separated power supplies, which would lead to overloading and overheating problem if either power supply is failed.

Note:

A decoder is unnecessary if the controller or dimmer can control the light directly. In this case, its connection position and way are the same as the above decoder's.